

ecoHITCH -Designed Specifically For Your **Green Vehicle**

Installation Instructions

Application Fits
2012-2015 Volkswagen Passat
X7317 & X7318
2" & 1.25" EcoHitch Stealth

200 lb. Tongue Weight/ 2,000 lb. Towing Weight

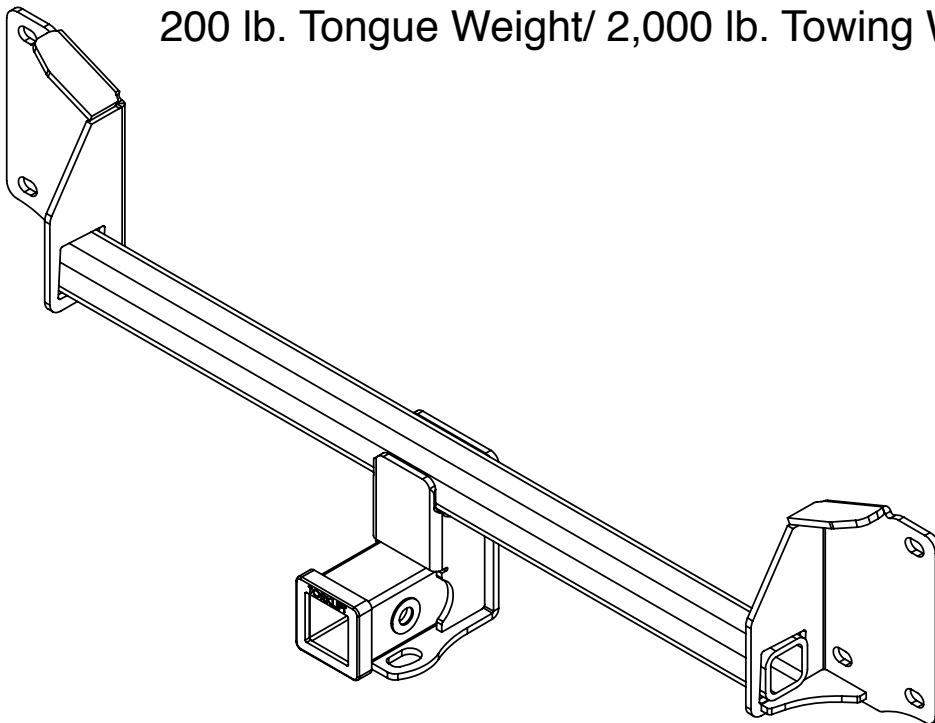

Torklift Central
315 Central Ave N
Kent, WA 98032
253-854-1832
www.torkliftcentral.com
support@tlcentral.com

Stay Connected



Bolt Kit Weight: 601g +/-

Hardware Included

QTY Fastener

- 6 5/16" Flat Washer
- 6 5/16" Lock Washer
- 6 M8-1.25x40mm Hex Cap Screw

READ THESE INSTRUCTIONS THOROUGHLY AND ACCOUNT FOR ALL HARDWARE LISTED BEFORE BEGINNING INSTALLATION!

Step 1. Raise vehicle on suitable jack stands, ramps, or hoist.

Step 2. Remove the (9) fasteners along the bottom of the bumper fascia from the driver side to the passenger side. Peel back the wheel well liner where the bumper fascia meets the main side body panels. Here you will find (1) torx screw to remove in each of the wheel wells.

See Figures [1] - [8].

NOTE: Figure [2] shows a trimmed bumper from a later step.

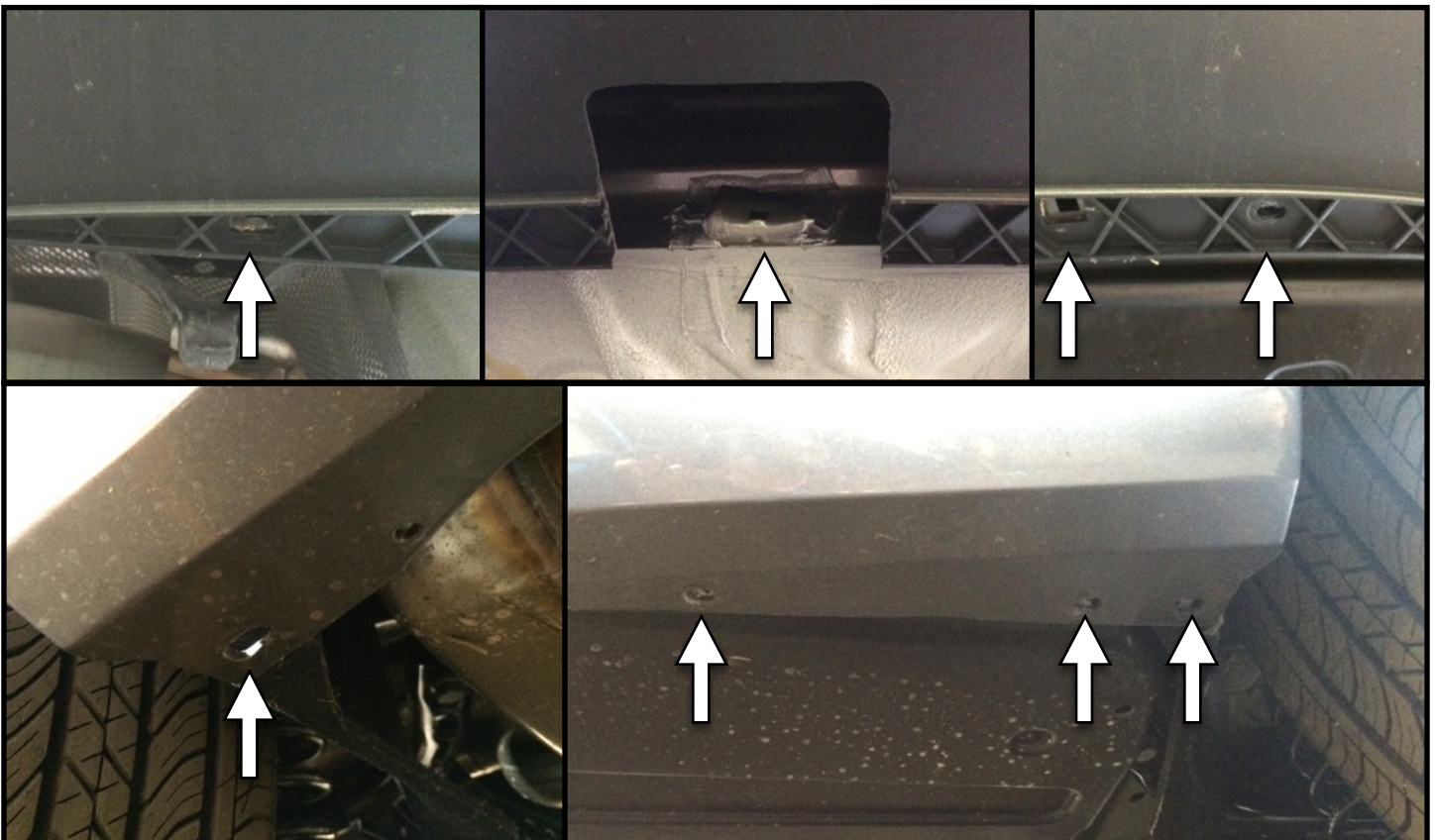

Step 2 Continued.



Fig. [6]

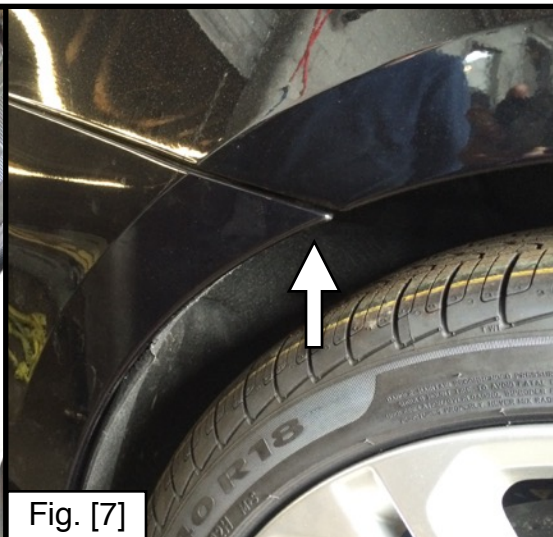

Fig. [7]

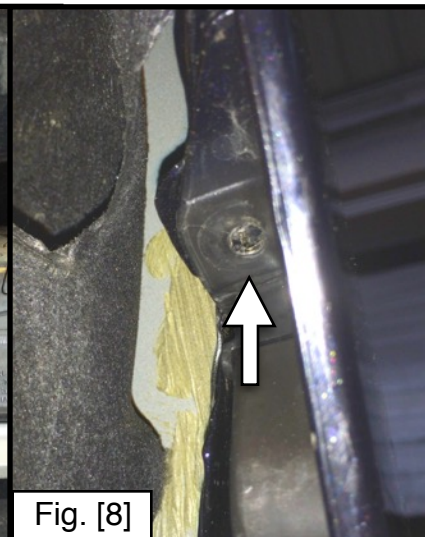

Fig. [8]

Step 3. Open the trunk lid and open the Tail Light Assembly (TLA) access panels. Remove the TLA Securing Pin and slide the TLA rearward. Disconnect the TLA wire harness to completely remove. See Figure [9], [10], & [11].

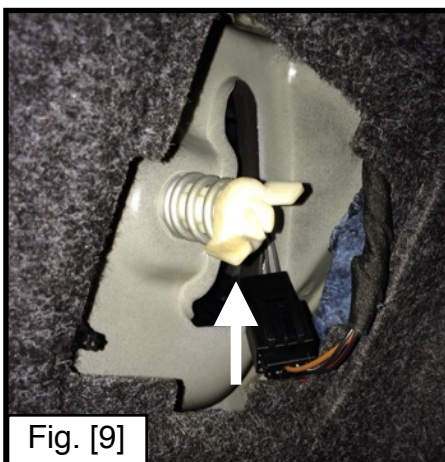

Fig. [9]



Fig. [10]

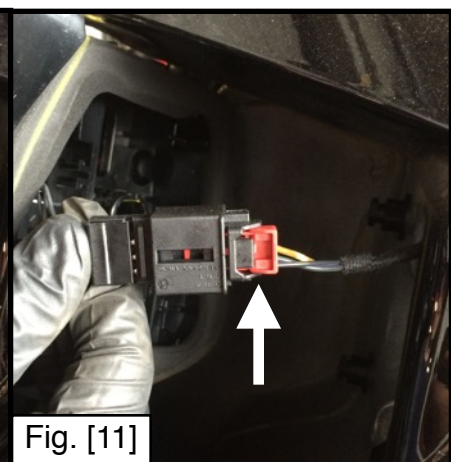

Fig. [11]

Step 4. Remove the (2) torx screws from each of the TLA areas of the bumper. Starting at the driver side wheel well, begin to peel the bumper fascia away from the vehicle. Pull the bumper rearward at the center section to completely remove. See Figure [12] & [13].

NOTE: Assistance during this step is recommended to avoid dropping and damaging the bumper.



Fig. [12]



Fig. [13]

Step 5. Remove and discard the foam piece on the impact bar. Remove the (6) factory hex cap screws and discard. See Figure [14] & [15].

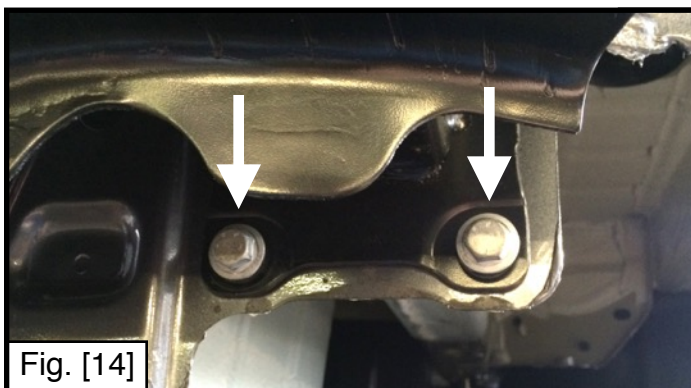

Fig. [14]



Fig. [15]

Step 6. Thread (1) M8-1.25x40mm Hex Cap Screw through the back of the impact bar weld nut on the driver and passenger sides as a temporary mounting bolt. Bend upwards or completely remove the center metal tab to clear room for the hitch cross tube. See Figure [18] & [19].

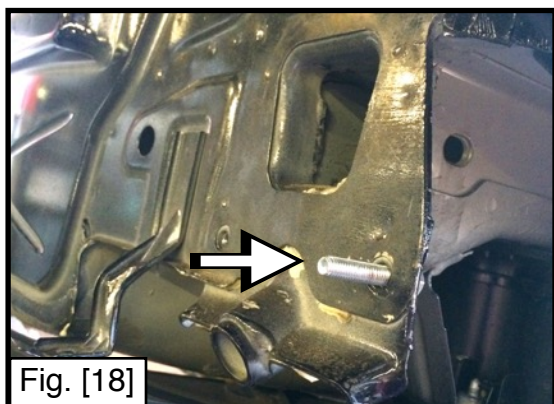

Fig. [18]

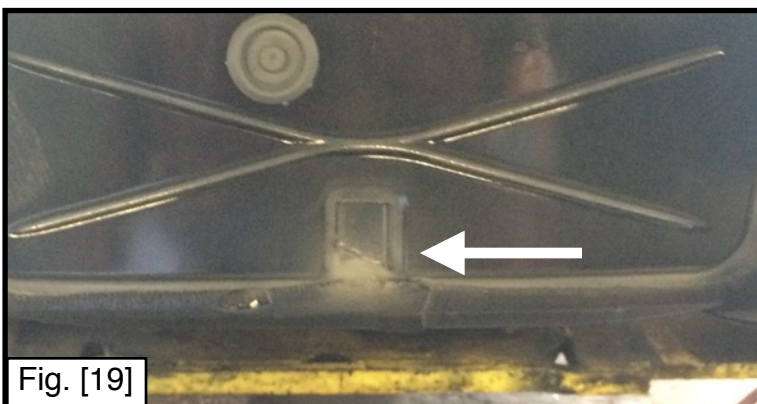
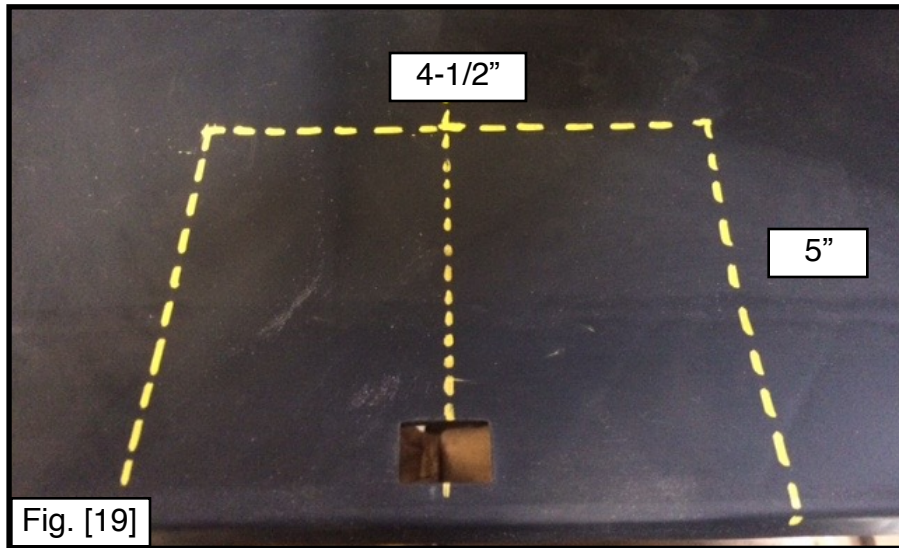

Fig. [19]

Step 7. Place the hitch onto the temporary bolts and then the impact bar over the hitch and thread (1) M8-1.25x40mm Hex Cap Screw, (1) 5/16" lock washer, and (1) 5/16" flat washer through each of the (4) remaining impact bar weld nuts. Remove the temporary M8 mounting bolts and thread through the front of the 2-piece unit with (1) 5/16" lock washer and (1) 5/16" flat washer. Once all the M8 hardware has been hand tightened and the hitch centered on the vehicle, torque the M8 bolts to 18 ft-lbs.

Step 8. Mark and trim a 4-1/2"x5" section from the center of the bumper. Reinstall the bumper by following these instructions in reverse starting at Step 4. See Figure [22].



Congratulations on the completed installation of the Volkswagen Passat Stealth EcoHitch! It is designed with a lifetime warranty for a lifetime of enjoyment. If you have any questions or suggestions please contact our tech support at support@tlcentral.com or by phone at (253) 854-1832.



WARRANTY/DISCLAIMER INFORMATION

Torklift Central requires proof of purchase for warranty claim registration, with pictures of any defective product before issuing a replacement. Torklift will not accept claims on any product without proof of purchase, which can be faxed, scanned, emailed or mailed to the information provided below. Torklift Central warrants its hitches, custom hitch receivers and accessories (excluding electrical wire harnesses which carry a warranty from their specified manufacturer) from date of purchase against defects in material and workmanship under normal use and service for the ownership life of the original consumer purchaser. Torklift Central will replace free of charge any part that proves defective in material or workmanship when presented to Torklift Central, transportation charges prepaid by purchaser, at the address below. **This warranty is limited to defective parts replacement only. Labor charges and/or damage incurred in installation or replacement, as well as incidental and consequential damages connected therewith are excluded.** This warranty does not include normal wear and tear or the finish and paint. Rusting, cracking or peeling of the finish is also excluded. Some states do not allow the exclusion or limitation of incidental or consequential damages, so the above limitation or exclusion may not apply to you. Any damage to Torklift Central products as a result of misuse, abuse, neglect, accident, improper installation or any use violative of instructions furnished by Torklift Central will void the warranty. This warranty gives you specific legal rights and you may also have rights, which vary from state to state. With warranty service, you may be able to go to a small claims court, a state court or a federal district court.

Although Torklift Central trailer hitches are both tested and rated for towing within the specific capacity label found on each trailer hitch. Torklift Central assumes no liability for vehicle manufacturers warranty due to the use of a Torklift Central trailer hitch being used for towing behind any vehicle or using the trailer hitch in a manner that it was not designed for. Although this specific trailer hitch has a load rating, which includes trailer tongue weight, and a trailer weight carrying capacity, Torklift Central is not responsible for the voiding of any warranty on any vehicle due to factory towing limitations. All vehicle warranties are the sole property and responsibility of the owner of the vehicle that the Torklift Central trailer hitch is installed upon. Torklift Central does not endorse towing behind any vehicle if the vehicles manufacturer states that towing is not recommended. Check your vehicle's owner's manual for the proper tow rating of your vehicle.

ADDRESS: 315 Central Ave N. Kent, WA 98032

WARNING Your vehicle may have a lower tow rating than this trailer hitch. If your vehicle's tow rating is less than the rated towing capacity on your Torklift Central trailer hitch, your trailer hitch capacity is limited to your vehicle's factory rated towing capacity.

FOR EXAMPLE: the label on your Torklift Central trailer hitch states it's capacity is rated for 500 pounds tongue weight and 5,000 pounds towing weight. However your vehicle's factory rated towing capacity is limited to only 350 pounds tongue weight and 3,500 pounds towing weight. In this example your maximum towing capacity of your Torklift Central trailer hitch is limited to 350 pounds tongue weight and 3,500 pounds towing weight as stated by your vehicle's maximum factory tow rating.

DANGER Never exceed your vehicle's manufacturer's recommended towing capacity which may be a lower rating than this trailer hitch

Unsure of your tow rating? Download our towing app from the app store to find your vehicles tow rating.
www.torkliftcentral.com/app.php